

GENERAL

ALIAMAG The AMF500 Series is a wafer type electromagnetic flowmeter ideal for conductive liquids. It comes in sizes from 50-200 mm. AMF500 is widely used for tap-water, waste water, food & beverage, pulp & paper and many other industrial fluid. AMF500 Series electromagnetic flowmeter could be used in compact or remote model with AMC Series converter of electromagnetic flowmeter.

FEATURES

- Light and compact version
- Flow Velocity range: 0-12 m/s, precise in low flow applications
- It comes any fange such as ANSI, DIN, JIS etc.
- Excellent for high pressure application
- Protection class: IP68 available; sensor submersible
- Available in PTFE and Polyurethane liner
- High accuracy of +/-0.4% value of reading (or +/-0.2% value of reading)
- With Forward / Reverse flowrate measurement function
- It has electrode cleaning function

STANDARD SPECIFICATION

- | | | | |
|-------------------------|--|------------------------|--|
| ● Size | : 50, 65, 80, 100, 125, 150, 200 mm | ● Cable Entry | : Standard: M20 Option: 1/2" NPTF |
| ● Measuring Range | : Velocity 0-0.25 m/s Min.
0-12 m/s Max. | ● Ambient Temperature | : -25~60 °C |
| ● Material | | ● Process Connection | : Wafer |
| Measuring Tube | : Stainless Steel 304 | ● Flange Type | : JIS 10K / JIS 20K / JIS 40K
ANSI 150# / ANSI 300# / ANSI 600#
DIN PN10 / PN16 / PN25 / PN40 |
| Coil Housing | : Carbon Steel (Standard)
: Stainless Steel 304 (Option)
: Stainless Steel 316 (Option) | ● Grounding Resistance | : Must be less than 10 Ω |
| ● Liner | : PTFE, Polyurethane | ● Accuracy | : +/-0.5% of reading (Velocity ≥ 0.5 m/s)
: +/-0.2% of reading
(Suitable for AMC3200 / 3200E converter) |
| ● Protection Class | : Junction box IP67, Body IP68
: IP68 (Submersible) | ● Temperature | : -20~70 °C (Polyurethane, PU)
: -40~120 °C (PTFE 2"-8")
: -40~140 °C (PTFE 2"-6") |
| ● Conductivity | : More than 5 μS/cm | ● Standard Pressure | : 40 kgf/cm ² (DN50-DN80)
: 16 kgf/cm ² (DN100-DN150)
: 10 kgf/cm ² (DN200) |
| ● Electrode & Grounding | : Stainless Steel 316L
: Hastelloy B
: Hastelloy C
: Titanium
: Tantalum
: Tungsten Carbide
: Platinum | ● Explosion Proof | : Ex d ia [ia] q IIC T6
(with AMC3200, AMC3200DF only) |



FLOW RANGE

Unit: m³/hr

Normal Size		Flow Range & Velocity Table						
mm	Inch	Min. 0-0.25 m/s	1.0 m/s	2.0 m/s	3.0 m/s	5.0 m/s	10.0 m/s	Max. 0-12 m/s
50	2"	0 to 1.77	7.07	14.1	21.2	35.3	70.7	0 to 84.8
65	2-1/2"	0 to 2.99	11.9	23.9	35.8	59.7	119	0 to 143
80	3"	0 to 4.52	18.1	36.2	54.3	90.5	181	0 to 217
100	4"	0 to 7.07	28.3	56.5	84.8	141	283	0 to 339
125	5"	0 to 11.0	44.2	88.4	133	221	442	0 to 530
150	6"	0 to 15.9	63.6	127	191	318	636	0 to 763
200	8"	0 to 28.3	113	226	339	565	1131	0 to 1357

DIMENSIONS

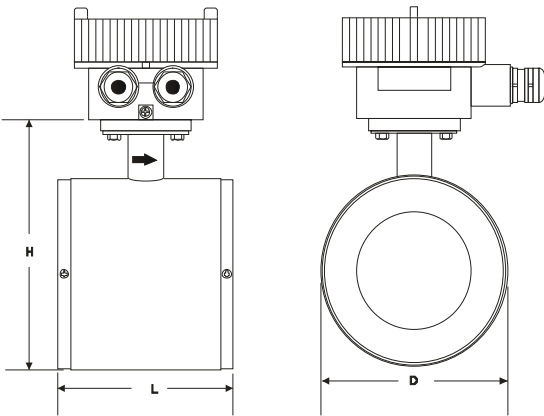

Size		Dimensions (mm)			Weight
mm	Inch	L	D	H	kg
50	2"	115	100	167	5.0
65	2-1/2"		120	187	6.3
80	3"	130	131	198	6.5
100	4"	155	151	218	9.0
125	5"		181	248	11.0
150	6"	185	206	273	13.5
200	8"	215	261	328	21.0

WIRING DIAGRAM

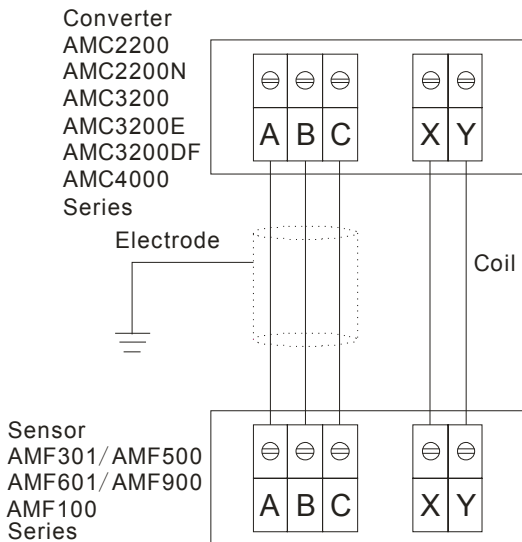

MODEL SELECTION GUIDE

AMF500 Series										
Example: AMF500-O080-CE80-050-40										
AMF500-	X	XXX	-X	X	X	X-	XXX	-XX	Description	
Liner	P								PTFE	
	O								Polyurethane	
Size	050-200									50-200 mm
Electrode Material	-S								Stainless Steel 316L	
	-T								Titanium	
	-B								Hastelloy B	
	-C								Hastelloy C	
	-A								Tantalum	
	-P								Platinum	
	-U								Tungsten Carbide	
	-Z								Others	
Grounding	N								None	
	E								Grounding Electrode (3 Electrodes)	
	R								Grounding Ring (S.S. 316)	
	A								Grounding & Protection Ring (S.S. 316)	
Protection Class	8								Junction box IP67, Body IP68	
	9								IP68 (Submersible, Remote with Converter Only)	
Housing Material	0-								Carbon Steel (Standard)	
	8-								S.S. 304 Housing	
	9-								S.S. 316 Housing	
Installation & Cable Length	NNN									Compact Version
	005-300									Remote Version, Cable 5-300 m
Option	-NN	None								
	-EX	Explosion Proof, Ex d ia [ia] q IIC T6 (with AMC3200, AMC3200DF Only)								
	-XX	Max. Process Pressure (10 / 16 / 25 / 40 kgf/cm ²)								
	-T1	Max. Temp.: 120-140 °C								
	-PT	Cable Entry 1/2" NPTF								
	-CD	Electrode Cleaning Device (Only for 2 Electrodes (316L), Size ≥4")								
-LR	Low-resistance coil (with AMC3200DF only)									

➤ BUILD OPTIONS-(COMPACT OR REMOTE)

